

120mm**San Ace B120**

32mm thick

**General Specifications**

- Material Frame: Plastics (Flammability: UL94V-0),
Impeller: Plastics (Flammability: UL94V-0)
- Expected Life Refer to specifications (L10:Survival rate: 90% at 60°C ,
rated voltage, and continuously run in a free air state)
- Lead Wire ⊕red ⊖black (Sensor) yellow (Control) brown
- Storage Temperature -30°C to +70°C (Non-condensing)

120mm × 32mm [Mass : 340g] **Specifications** The following nos. **have PWM controls and pulse sensors.**

Model No.	Rated Voltage [V]	Operating Voltage Range [V]	PWM duty cycle ¹⁾ [%]	Rated Current [A]	Rated Input [W]	Rated Speed [min ⁻¹]	Max. Air Flow [m ³ /min] [CFM]	Max. Static Pressure [Pa] [InchH ₂ O]	SPL [dB(A)]	Operating Temperature [°C]	Expected Life ²⁾ [h]
9BFB12P2H003	12	10.8 to 13.2	100	2.3	27.6	3,750	1.6 56.5	1,250 5.02	62	-20 to +70	40,000/60°C (70,000/40°C)
9BFB24P2H003	24	21.6 to 26.4	0	1.1	26.4	3,750	1.6 56.5	1,250 5.02	62		
			0	0.12	2.88	1,300	0.46 16.2	43 0.17	41		

Note 1 : 9BFB12P2H003, 9BFB24P2H003 does not rotate when PWM duty cycle is 0%.

※PWM Frequency : 25kHz

Note 2 : Expected life at 40°C ambient is just reference value.

- Available options: ⇒ **Without Sensor** **Pulse Sensor**

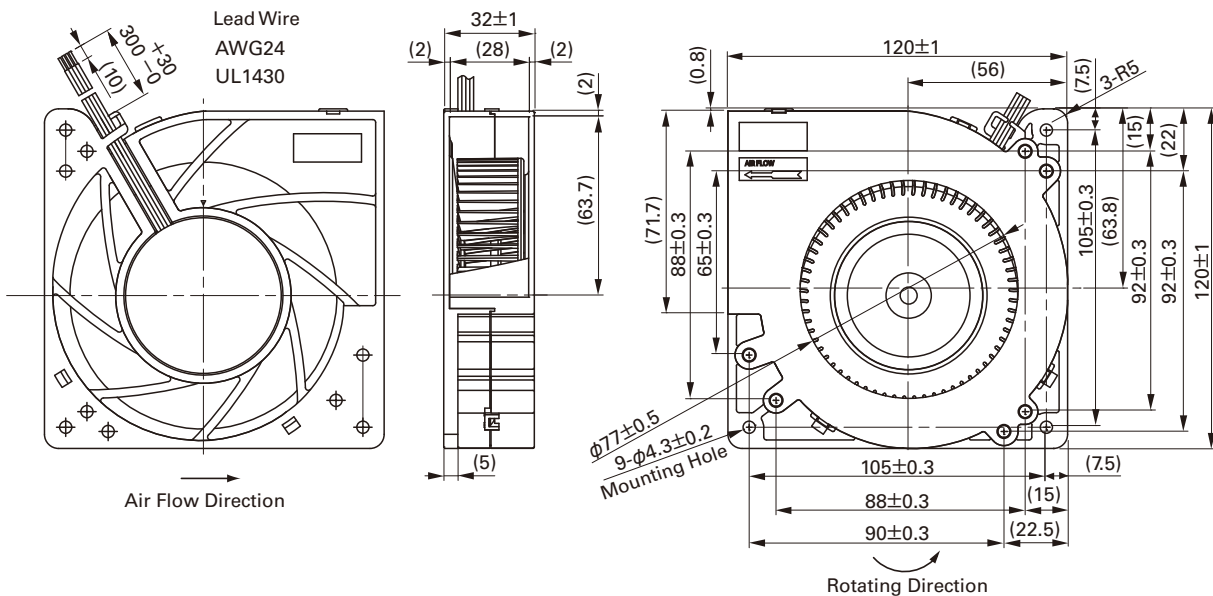
Dimensions (Unit : mm)

Air Flow - Static Pressure Characteristics

PWM Duty Cycle

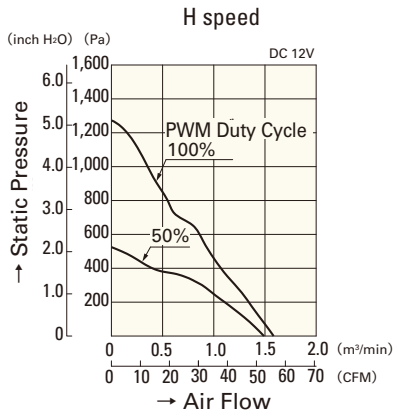

9BFB12P2H003

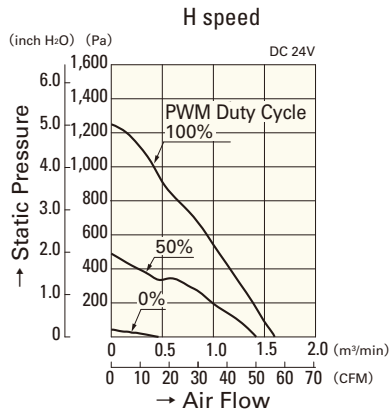

9BFB24P2H003

Operating Voltage Range

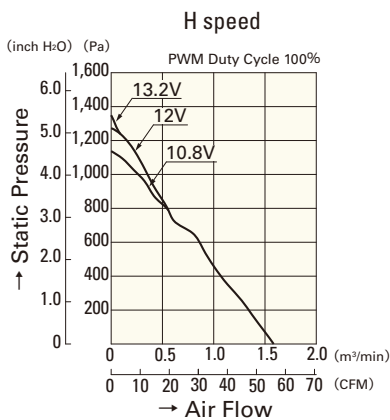

9BFB12P2H003

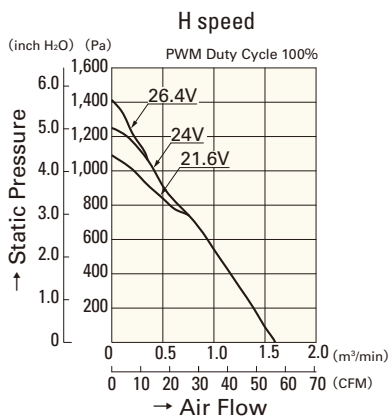

9BFB24P2H003

PWM Duty - Speed Characteristics Example

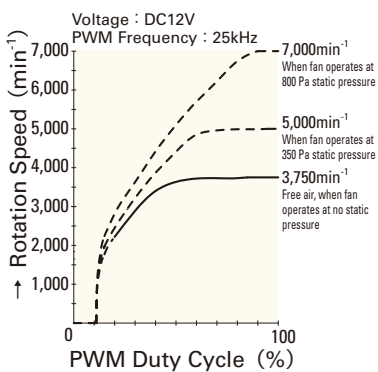

9BFB12P2H003

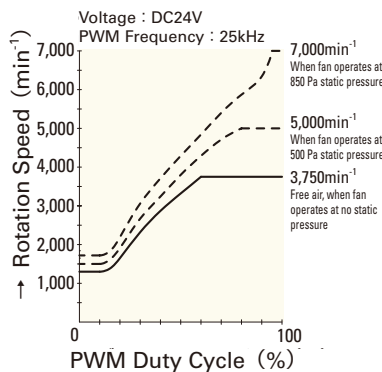

9BFB24P2H003